

ESTORES NOCHE Y DÍA GUÍA DE INSTALACIÓN

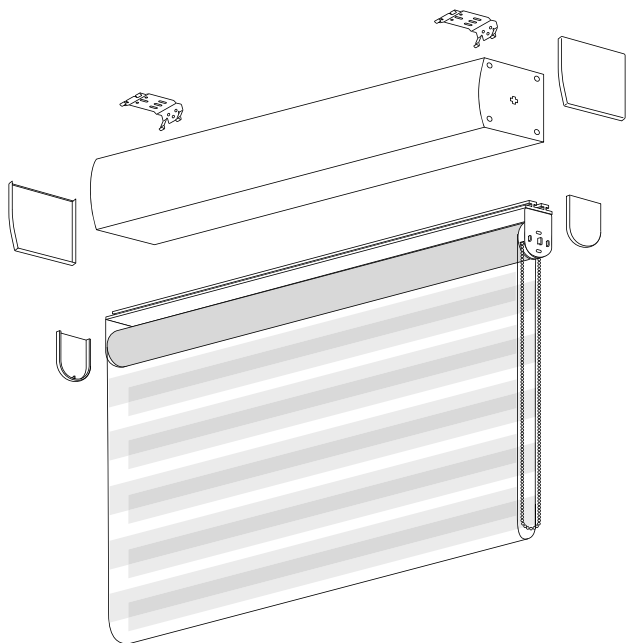

Comprobamos las piezas

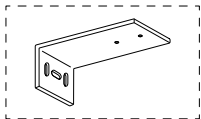

Escuadras
(opción pared)

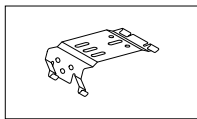

Soportes

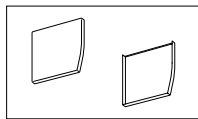

Embellecedores

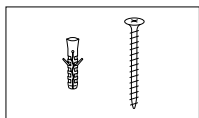

Tacos y tornillos*

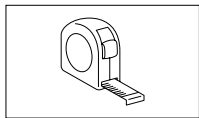

Cinta métrica

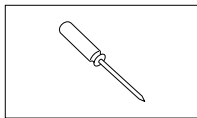

**Destornillador
de estrella**

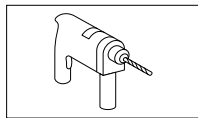

Taladro

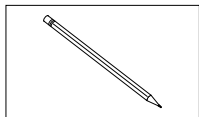

Lápiz

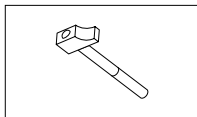

Martillo

**Si la instalación se va a realizar en alguna superficie que no sea ladrillo, es recomendable adquirir alguna tornillería específica.*

1 | Ubicamos los soportes

INSTALACIÓN A PARED

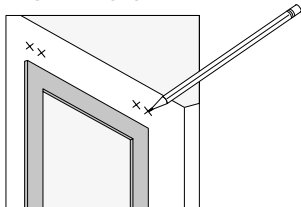

Medir y marcar

INSTALACIÓN A TECHO

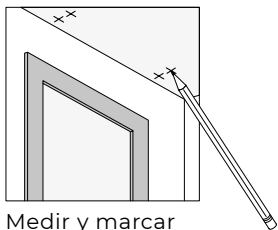

Medir y marcar

Con el metro, medimos y marcamos con un lápiz la ubicación de los soportes. Repartimos el número de soportes recibidos entre el ancho del estor.

2 | Fijamos los soportes

INSTALACIÓN A PARED

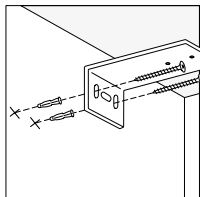

Taladrar y atornillar

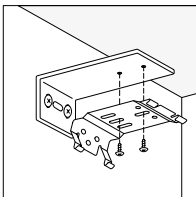

Unir

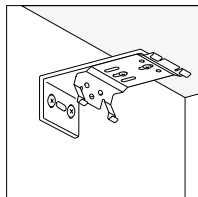

INSTALACIÓN A TECHO

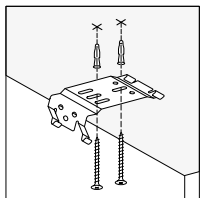

Taladrar y atornillar

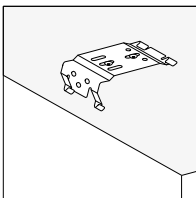

PARED

Taladramos, colocamos los tacos y fijamos las escuadras. A continuación, unimos los soportes a las escuadras.

TECHO

Taladramos, colocamos los tacos y fijamos los soportes.

3 | Colocamos el estor

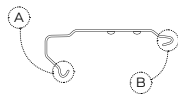

INSTALACIÓN A PARED

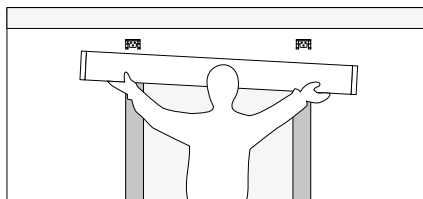

Posicionar

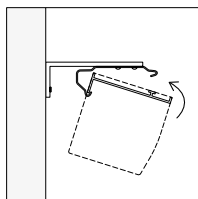

Enganchar

INSTALACIÓN A TECHO

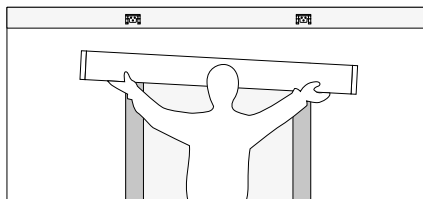

Posicionar

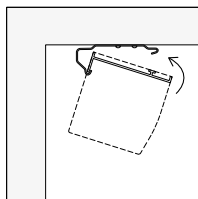

Enganchar

Inclinando el estor, lo enganchemos a la parte A del soporte. A continuación, lo enderezamos hacia arriba para engancharlo a la parte B hasta que haga « clic ».

4 | Colocamos los embellecedores

A LA IZQUIERDA

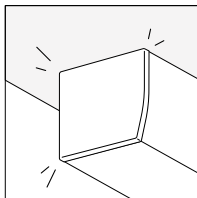
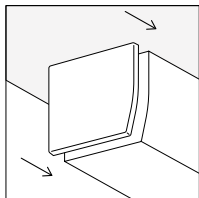

A LA DERECHA

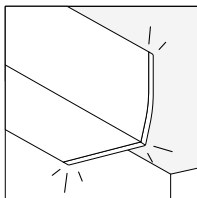
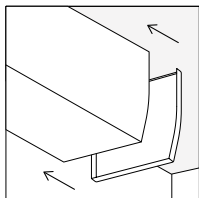

Atención al cliente

decormaraza@cortinas.net.pe

918 162 730

<https://cortinas.net.pe/>