

ESTORES ENROLLABLES

GUÍA DE INSTALACIÓN

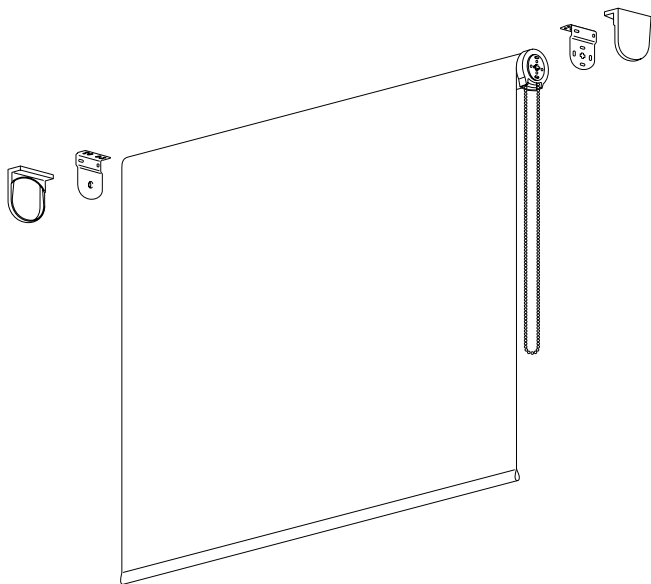

Comprobamos las piezas

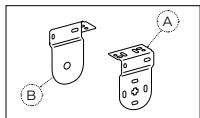

Soporte A
Soporte B

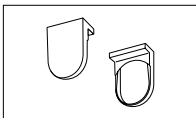

Embellecedores

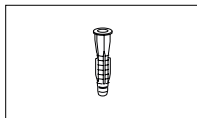

Tacos*

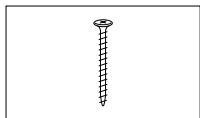

Tornillos*

Necesitamos

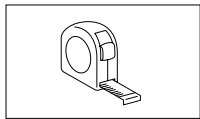

Cinta métrica

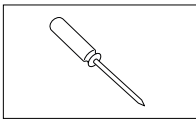

**Destornillador
de estrella**

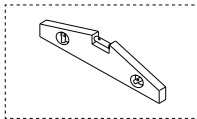

**Nivel
instalación a pared**

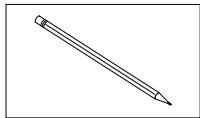

Lápiz

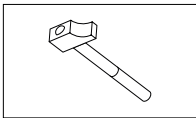

Martillo

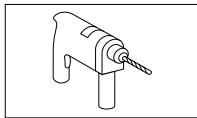

Taladro

**Si la instalación se va a realizar en alguna superficie que no sea ladrillo, es recomendable adquirir alguna tornillería específica.*

1| Ubicamos el soporte A

INSTALACIÓN A PARED

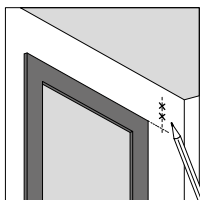

Medir y marcar

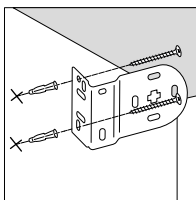

Fijar

INSTALACIÓN A TECHO

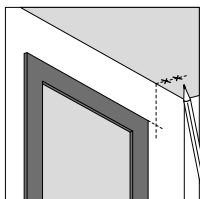

Medir y marcar

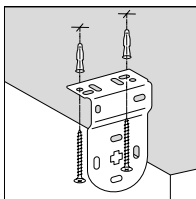

Fijar

El primer soporte que colocaremos será el **soporte A**. Este soporte se coloca **en el lado donde queremos el mecanismo** (cadenilla o motor).

Con el metro, medimos y marcamos su ubicación. Taladramos, colocamos los tacos y fijamos el soporte.

2 | Ubicamos el soporte B

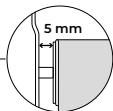

INSTALACIÓN A PARED

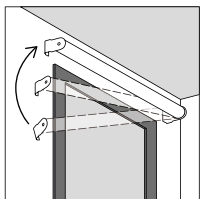

Colocar

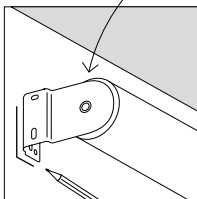

Marcar

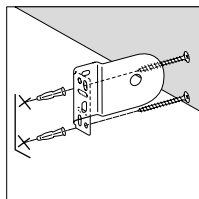

Fijar

INSTALACIÓN A TECHO

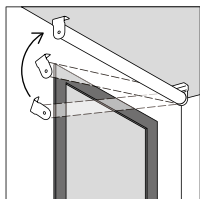

Colocar

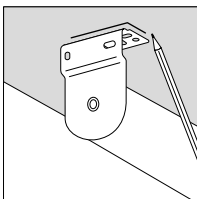

Marcar

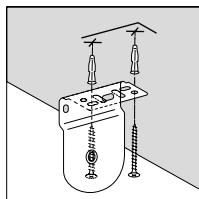

Fijar

Introducimos el estor en el soporte A ya colocado y calculamos donde se ubicará el soporte B, **dejando medio centímetro** entre el soporte B y el estor como en el dibujo. Marcamos su ubicación con un lápiz, quitamos el estor, taladramos, colocamos los tacos y fijamos el soporte B. Es recomendable usar el nivel para la instalación a pared.

3 | Colocamos los embellecedores

INSTALACIÓN A PARED

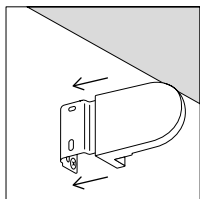

Soporte B

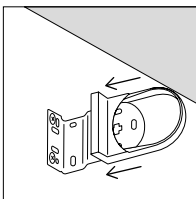

Soporte A

INSTALACIÓN A TECHO

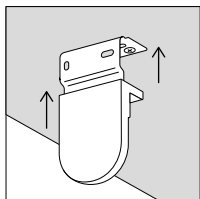

Soporte B

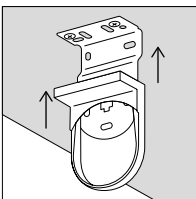

Soporte A

4 | Fijamos el enrollable

INSTALACIÓN A PARED

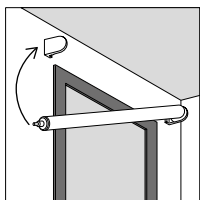

Colocar

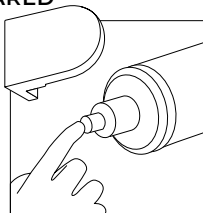

Presionar

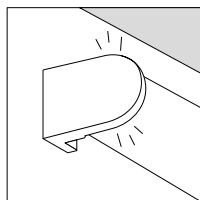

Clic

INSTALACIÓN A TECHO

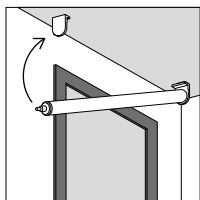

Colocar

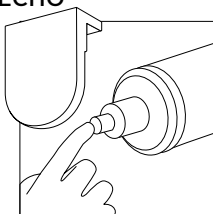

Presionar

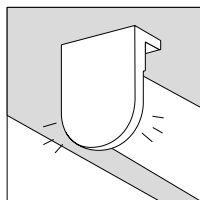

Clic

Introducimos el extremo del estor que lleva el accionamiento (cadenilla o motor) en el soporte A. A continuación, presionamos el otro extremo del estor para fijarlo en el soporte B hasta que haga « clic ».

Atención al cliente

decormaraza@cortinas.net.pe

918 162 730

<https://cortinas.net.pe/>